

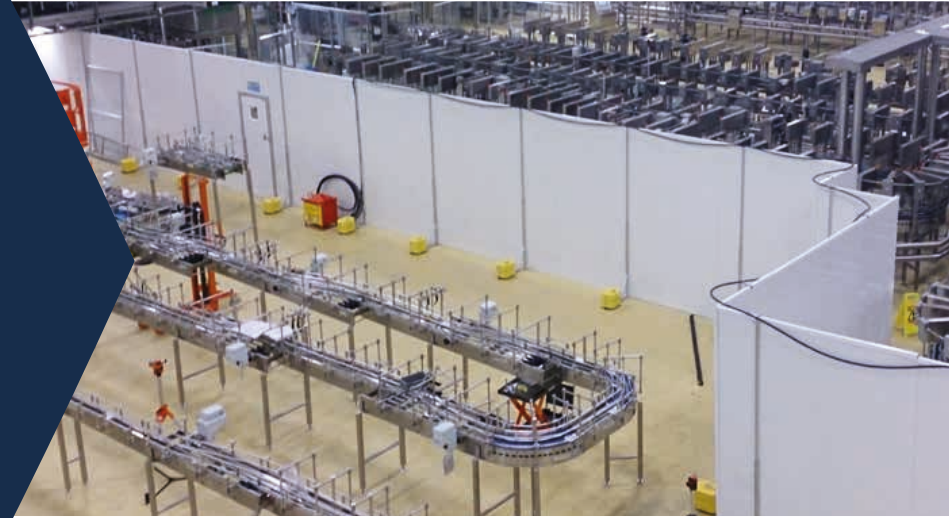

Factory & Warehouse
Partitions, Curtains, Screens,
Temporary Buildings & Accessories





Working with Westgate Global
over 45 years experience 6



Flexiwall
floor-to-ceiling fabric partition wall 12



Flexiscreen
temporary dust tight building screen 16

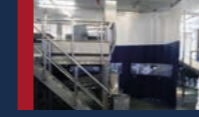

Flexicurtain
retractable PVC fabric curtain 20

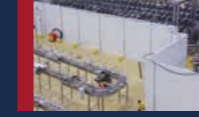

Hoardfast
modular partitioning system 24



Anchorwall
steel partition walling system 28



Flexistrukture
temporary external building 34

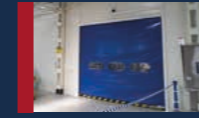

Fastflex
fast action industrial doors 40

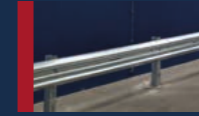

Access & Protection Systems
optional extras 44



Easipanel
reflective roof light cover 48

Design, Supply & Install

Across UK & Europe

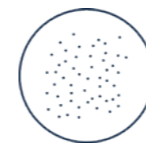

Dust prevention



Temperature control



Noise & odour reduction



Contamination control



Fire protection



Additional space



Automotive & Aerospace



Construction



Food & Beverage



Manufacturing (inc. Pharmaceutical)



Data Centres



Warehouse & Logistics

Operating across multiple sectors, we channel our collective expertise to deliver solutions that reduce cost and drive efficiency...

- Use our experience to help specify the solution that's best for your project
- Our range provides an integrated solution from a single supplier
- Technical data available in -house and on-site surveys carried out as part of your project
- Materials and manufacturing processes are standardised to be cost effective but products are customised to meet your requirements
- Our products are manufactured and finished off-site to minimise the impact and disruption during on-site installations
- Product installation methods are quick and clean to minimise hygiene impacts
- Where production needs to meet the requirements of BRC accreditation, our products use antibacterial materials

Why Westgate?

Westgate Global are market leaders in industrial factory and warehouse partitions, curtains and screens, temporary industrial buildings and construction and fit out hoarding...

Our practical products solve issues with dust, temperature, cross contamination, additional space and more. Our product ranges are customised to adapt to different scenarios and situations, delivered using modular systems for quick turn around and ease of installation, minimising disruption on site.

The innovative range of Westgate products enable fast non-disruptive installation, allowing minimum downtime and maximum flexibility for your developing environment, plus short and long term cost savings when compared to more traditional or conventional methods. We design our systems to be reusable where possible, being adaptable, reconfigurable, relocatable and designed to leave no lasting damage to buildings.

Servicing the UK and Europe, we work with large brands across a wide range of sectors including manufacturing and production (automotive and aerospace, pharmaceutical, food, beverage and general manufacturing), warehousing and logistics, data centres, new build construction and fit out and refurbishment (offices, retail, airports and healthcare).

Specialising in design, supply and installation since 1977, we have over 45 years experience delivering your project from concept to completion. We work together and use our expertise to specify the right systems, and assist you in your choice from our standard core range or in delivering a custom-made multi-system solution to meet the needs of your individual project and business.



Flexiwall
Kingsland Drinks

“

This is the 3rd project I have worked with Westgate on and each time the product and service delivered has been excellent. Flexiwall goes up quickly with minimal fuss and gives us the future flexibility that we require.”

Flexiwall – Great Bear



Flexistrukture
Eurocell



Flexiwall
Great Bear

“

Westgate were able to accommodate our request for a quick installation programme and the installation team completed works in a safe and efficient manner. Throughout the process communication with Westgate was excellent and the finished product is perfect for our requirements.”

Hoardfast Flamescreen / Flexiwall – Balfour Beatty

Hoardfast Flamescreen / Flexiwall

Balfour Beatty



Anchorwall / Flexiwall
Royal Mail

Westgate provide a range of part-height, floor-to-ceiling, temporary to permanent partitions, all designed to help customers segregate space.

We also provide a range of additional products to enable an integrated solution; Fastflex fast action doors, access solutions, Easiguard protective barrier systems, and Anchorwall pedestrian doors.

Our solutions work across all processing, manufacturing, warehouse (storage and distribution) facilities.

We believe that the quality of our products and service performance is fundamental to our ongoing success, so we've worked hard to comply with ISO 9001:2015/ISO 14001:2015 and other accreditors such as ConstructionLine, SMAS and Safe Contractor.

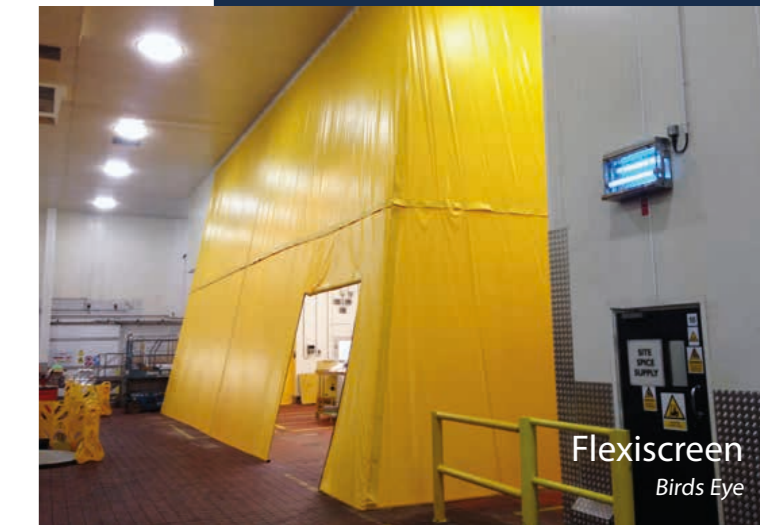

Flexiscreen
Birds Eye

”

“Having worked with Westgate previously, it was no surprise that their Flexiscreen dust screen and expertise were ideal for our requirements. The screen did exactly what we needed it to do and offered us robust protection against contamination control during refurbishment works.”

Flexiscreen – Birds Eye

Partitions, Screens & Curtains

Reconfigure. Relocate. Remove.



Semi-Permanent

Adapt to unforeseen or unpredictable future business changes with partitions and screens that can be easily reconfigured, relocated or removed without damage to the building and products proven to stand the test of time.



Installation Speed

Save time and money; our range of fabric partitions, screens and curtains are pre-designed and pre-manufactured off site, meaning they install quickly and cleanly minimising disruption to your ongoing operation.



Custom-Made

Our solutions are delivered from a range of standardised elements, custom-made to suit the bespoke nature of your building and project.

Benefit from in-house consultation to achieve budgets and timescales.

Flexiwall®
industrial partitioning

Floor-to-Ceiling Reinforced Fabric Partition Wall



Flexiwall is a unique reinforced PVC fabric, floor-to-ceiling partition wall that offers multiple benefits over traditional partition methods.

Manufactured from light-weight fire rated material, Flexiwall is quick and clean to install and can even be reconfigured, removed or relocated should business needs evolve.

Flexiwall can be designed to fit any size and shape of building and will easily install around existing ducts, pipework, equipment and racking.



ASK US
FOR A
FABRIC
SAMPLE

Key Features



Floor-to-Ceiling; any Height and Length



No Mess, Quick/ Easy Installation



Minimal Floor Space Required



Easily Reconfigure, Remove or Relocate



Fire Rated Material Options



Cost Effective Solution

Typical uses include;

- Dust prevention
- Temperature control
- Storage and production segregation
- Prevent cross contamination in goods storage
- Enclose external canopies
- Enclose mezzanine floors

Benefits

- No height or width restrictions for installation
- Creates an over 99% dust tight seal
- Only requires millimetres of floor space allowing it to be installed in tight spaces, reducing the need to move existing equipment/racking
- Minimal impact on existing production and operation schedules with quick and clean installation
- Adapt to unforeseen or unpredictable future business changes with a partition that can be easily reconfigured, removed or relocated without damage to the building
- Reduced overall project costs as no need to relocate services
- Design with corporate colours and logos
- Translucent, fire resistant and insulated material options available
- Choose from a range of optional extras to create an integrated solution
- Include doors, vision panels and tear off fire exits to suit your requirements

Technical Data

Material composite:	Main product is polyester reinforced fire-retardant fabric with PVC coatings. We also supply a non-combustible woven glass fabric with PU coating (*range of base fabric and coatings depending on project requirements)
Material weight:	between 340gsm-1300gsm
Tensile strength:	between 340N-4000N / 50mm
Tear strength:	between 80N-850N
Material fire rating examples:	BS 5867:2008 Part 2 Type A & B, Warrington Certifire TS62 & TS63, EN13501-1 A2s1d0, EN13501-1 Bs2d0, EN13501-1 Cs2d0 (*subject to material specification, all fire ratings supplied at quote stage)
Operating temperature:	between -40 / +500 degrees centigrade (*dependent on fabric)

Installation

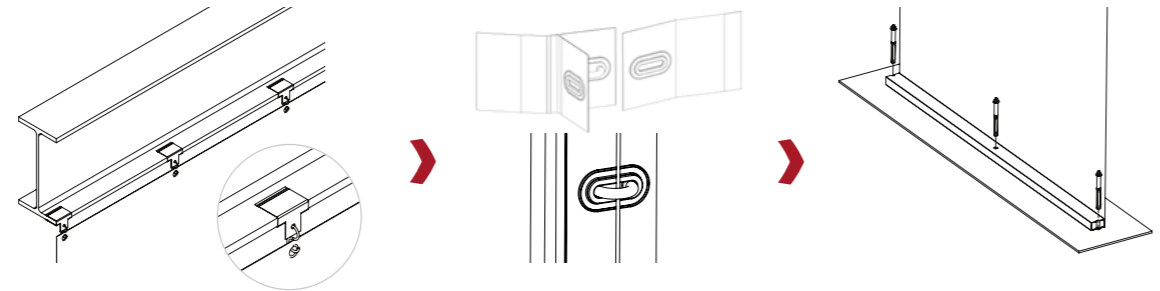

Panels are suspended using existing steelwork clips and s-hooks

Panels are joined together using our unique v-overlap system

Panels are tensioned and secured using a batten fixed to the floor

Optional Extras: Door, Access and Protection Systems - page 38



We have created solutions for many including...



Call us today on
+44 (0)1785 242181
and book a site survey...

Could Flexiwall work for you?
Scan the QR code to learn more:



Flexiscreen®

high grade building screen



Temporary Building Screen

Flexiscreen is a temporary floor-to-ceiling screen, used to contain dust during construction, flooring, installation and extension works.

Flexiscreen is a quick turnaround building screen, which is fast, easy and clean to install and can be used for both internal and external applications.

During phased works it can be moved, reconfigured and extended if required.

The unique v-overlap system and tight seal around ducts, pipes, steel work and at ceiling level ensures that Flexiscreen offers an over 99% dust tight seal.



ASK US FOR A FABRIC SAMPLE

Key Features

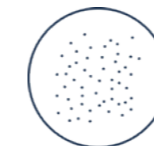

Over 99% Dust Containment



Cost-Effective alternative to Scaffold Sheets



Floor to Ceiling; any Height and Length



Antibacterial Materials



No Mess, Quick/Easy Installation



Fire Rated Materials

Typical uses include;

- Screen off production line installations to prevent cross contamination
- Dust containment during flooring and drainage works
- Create an enclosure around areas where a roof needs to be removed, for temperature and contamination prevention
- Internal relocatable screen to allow for phased openings
- Temporary external walls for weather protection during extension projects

Benefits

- Quick installation processes: maintain your existing production schedules
- Design and installation to suit any height and width (subject to survey)
- Unique v-overlap and installation methods create an over 99% dust tight seal
- Suspended panel-based system: requires no supporting structure as suspended from existing building structure
- Manufactured in the UK, for quick turnaround
- Wind load calculations and designs available for external walls or high wind load areas
- Can be installed on an angle in order to accommodate tight gaps
- Reconfigure or relocate easily during project phases, ability to open sections up
- Allows the transfer of light, no need to change the lighting system

Technical Data

Material composite:	Main product is polyester reinforced fire-retardant fabric with PVC coatings. We also supply a non-combustible woven glass fabric with PU coating <small>(*range of base fabric and coatings available depending on project requirement)</small>
Material weight:	between 175gsm-840gsm
Tensile strength:	between 800N-3400N / 50mm
Tear strength:	between 250N-850N
Material fire rating examples:	BS 5867:2008 Part 2 Type A & B, Warrington Certifire TS62 & TS63, EN13501-1 A2s1d0, EN13501-1 Bs2d0, EN13501-1 Cs2d0 <small>(*subject to material specification, all fire ratings supplied at quote stage)</small>
Operating temperature:	between -40 / + 70 degrees centigrade <small>(*dependent on fabric)</small>

Installation

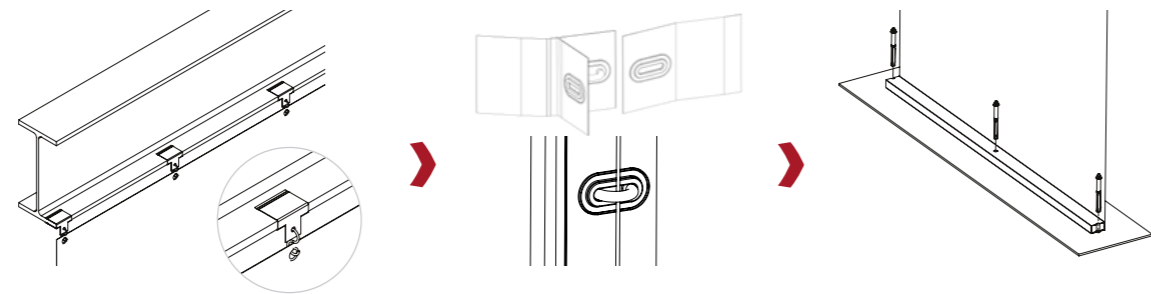

Panels are suspended using existing steelwork clips and s-hooks

Panels are joined together using our unique v-overlap system

Panels are tensioned and secured using a batten fixed to the floor

Optional Extras: Door, Access and Protection Systems - page 38



We have created solutions for many including...



Call us today on +44 (0)1785 242181 and book a site survey...

Could Flexiscreen work for you? Scan the QR code to learn more:



Flexicurtain®

industrial curtain

Retractable PVC Curtain Wall or Door

Flexicurtain is an internal or external retractable curtain wall used to provide temporary segregation of two areas.

Typical applications are to prevent cross contamination and overspray, create booths, segregate production lines during washdown, manage temperature and segregate large areas where regular access is required. Externally Flexicurtain can offer accessible entry with weather protection on canopies and enclosures.

Using a range of standard fire rated PVC materials, Flexicurtain can be designed bespoke with a number of optional extras.



ASK US
FOR A
FABRIC
SAMPLE

Key Features



Prevent Cross Contamination



Protect Employees



Quick to Deploy



Fire Rated Materials



Antibacterial Materials



Keep Production Moving

Typical uses include;

- Segregation of production lines for washdown processes
- Create a retractable wall which restricts airflow in order to manage temperature
- Prevent cross contamination between production lines
- Canopy enclosure and weather protection
- Employee protection; welding curtains, spray booths, robot surrounds
- Temporary retractable segregation where large construction equipment needs access

Benefits

- Installs quickly and cleanly
- Designed and manufactured to any height or length (subject to survey)
- Manual operation
- Range of bespoke design options
- Resistance tested against a range of cleaning products
- Anti-fungal materials for food, beverage and packaging environments
- Install wind load straps for external applications
- Optional extras include vision panels, stainless steel tracks, suspended tracks, single run or bi-parting applications, wind load straps (external applications) and electric operation

Technical Data

Material composite:	Main product is polyester reinforced fire-retardant fabric with PVC coatings. We also supply a non-combustible woven glass fabric with PU coating (*range of base fabric and coatings depending on your project requirement)
Material weight:	between 340gsm-840gsm
Tensile strength:	between 340N-3400N / 50mm
Tear strength:	between 80N-850N
Material fire rating examples:	BS 5867:2008 Part 2 Type A & B, Warrington Certifire TS62 & TS63, EN13501-1 A2s1d0, EN13501-1 Bs2d0, EN13501-1 Cs2d0 (*subject to material specification, all fire ratings supplied at quote stage)
Operating temperature:	between -40 / +70 degrees centigrade (*dependent on fabric)

Installation

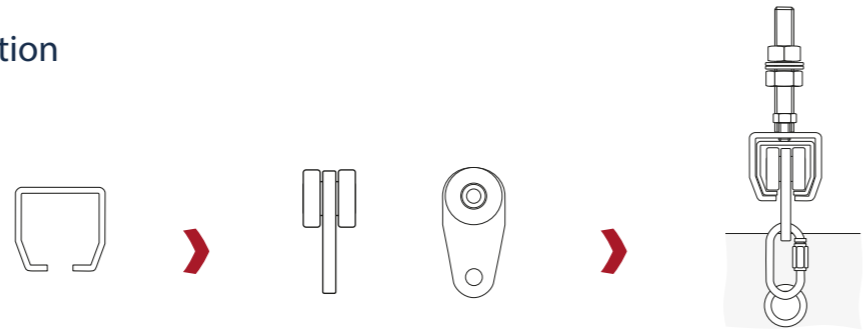

Flexicurtain is hung and runs on a rail which is installed bespoke, depending on the environment and what existing structure is available

Westgate's unique trolleys sit in the rail and provide a smooth run

Your chosen Flexicurtain material is then hung from the trolleys to create a retractable industrial curtain

Optional Extras: Door, Access and Protection Systems - page 38



We have created solutions for many including...



Call us today on
+44 (0)1785 242181
and book a site survey...

Could Flexicurtain work for you?
Scan the QR code to learn more:





Modular Partitioning System

The Hoardfast range is a quick to install, modular, part-height free-standing or floor-to-ceiling partitioning and screening system.

Hoardfast can be used as a temporary screen, permanent partition or to create internal rooms.

Available in a range of panel, support feet and stability options, Hoardfast's smart appearance fits seamlessly into any environment.

Panels supplied offer varied fire ratings (certifications are available on request) and panels within the range are available for purchase or hire.



ASK US FOR A FABRIC SAMPLE

Key Features



No Mess, Quick/Easy Install and Demount



In-stock Items with UK Next Day Delivery



Sustainable (uPVC made from Recycled Plastic)



Choose Hire or Purchase, and Install Service or Supply only

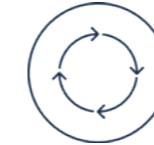

Relocatable and Reusable



Cost Effective - Save £££'s

Typical uses include;

- Free-standing solid dust screen during maintenance and installation projects
- Create separate rooms and areas in manufacturing facilities to prevent cross contamination (washrooms or allergen controlled zones)
- Protective barriers for pedestrian walkways and designated areas
- Privacy or noise barriers/screens
- Use alongside the Flexi range of products when a solid interface is required

Benefits

- Choose from a range of panels including fire resistant and sound reducing options
- Range of panels/sizes
- Floor-to-ceiling or part-height solutions
- Free-standing options prevent damage to floors (high stability available for high traffic areas)
- Supply only or use our certified and experienced installation teams
- Products delivered to site clean and ready to use
- High quality appearance for customer areas
- Optional extras include, single and double doors, vision panels and graphics

Technical Data

	Standard uPVC	Soundscreen	Flamescreen	Firescreen
Material composite:	85% recycled uPVC 15% virgin uPVC, grey hollow fluted internal and solid white micro ridged external face	white steel faced (perforated to construction side) mineral wool filled	white steel faced fire rated PIR foam filled	white steel faced mineral wool filled
Connecting method:	tongue and groove	tongue and groove push fit	tongue and groove push fit	tongue and groove push fit
Panel fire rating:	BS476 Part 7 Class 1 (Spread of Flame) and EN13501-1 C s3 d0 (35mm profile only)	EN13501-1 A2 s1 d0 fire class rating	EN 13501-1 B s2 d0 fire class rating	EN 13501-2:2008 A2 s1 d0 fire class rating / EI60 fire resistance
Acoustic properties:	26-27dB reduction in sound (insulation)	RW = 34dB (minimum)		
Thermal insulation (U-Value):	2.95 W/m2K (35mm profile) 2.43 W/m2K (50mm profile) *Theoretically calculated	0.75 W/m2K	0.61 W/m2K	0.5 W/m2K
Standard panel heights:	1.12m, 2.25m, 2.7m, 3m, 4m, 5m	2.7m, 4m	2.25m, 2.7m, 3.5m	2.25m, 2.7m, 3.1m, 3.5m, 4.0m, 4.5m
Panel width:	0.5m	1m	1m	1m
Panel thickness:	35mm (up to 2.7m), 50mm (3m-5m)	50mm	30mm	80mm
Panel weight:		14.5kg/m2	9.4 kg/m2	17.9 kg/m2
Support options:	floor-to-ceiling; supplied with u-channel fixings or free-standing; equal, offset, universal, bolt down	floor-to-ceiling; supplied with u-channels fixings or free-standing; universal	floor-to-ceiling; supplied with u-channel fixings or floor-to-ceiling; universal support	floor-to-ceiling; supplied with u-channel fixings or free-standing; universal support

Hoardfast Standard uPVC is a sustainable product.

Panels are recycled at end of life and funds created from recycling are donated to charities across the UK.



We have created solutions for many including...



Call us today on
+44 (0)1785 242181
and book a site survey...

Could Hoardfast work for you?
Scan the QR code to learn more:



Anchorwall®

steel partitioning

Part-Height Steel Partition

Anchorwall is a fixed part-height steel partition available in a single skin, double skin, mesh or perforated finish.

Typically used in manufacturing and warehouse environments, Anchorwall is a robust and sturdy solution when segregating open areas and creating enclosed work areas.

Typical panel heights from 2.4m or custom-made to suit project requirements, with a range of accessories, doors and glazing options.

Create a unique partition when used with Flexiwall above to deliver a floor-to-ceiling solution.



ASK US FOR A FABRIC SAMPLE

Key Features

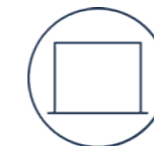

Fixed Partition



Range of Finishes



Range of Bespoke Panel Sizes



Door Options and Accessories



Fire Rated and Sound Reducing



Takes up Minimal Floor Space

Typical uses include;

- Fixed solid segregation to separate different operational processes or machines/equipment
- Security segregation to secure high value goods or provide restricted access zones (e.g chemicals and liquids)
- Subdivide storage areas
- Create enclosed work areas
- Create factory floor site offices
- Create clean rooms
- Create anti-collapse mesh screen panels
- Pedestrian walkways

Benefits

- Modular design allows for flexible installations
- Single skin offers a lighter weight alternative to the double skin option
- Single skin is ideal when a smooth finish is only required to a single side
- Double skin system available in and tested to various fire ratings
- Can be used multi-tier to suit various applications
- Mesh systems retain visibility and light transit
- Electrostatically powder coated panels
- A comprehensive range of accessories
- Range of bespoke panel sizes custom-made to suit your requirements
- Range of door and glazing options
- Range of paint finishes and colours
- As typical, panels are not insulated, however the double skin can be supplied with insulation

Technical Data

Panel composites:	full steel; steel/glass/steel; steel/glass; fully glazed; steel/mesh/steel
Paint finishes:	electrostatically powder coated in the following standard colours; light/medium/dark grey; sandstone; white; stone
Typical panel heights:	between 2400mm – 3000mm
Typical panel widths:	1000mm
Typical panel thickness:	between 43mm – 47mm (mesh constructed from weld mesh 50x50x3mm (10g) spot welded to frame)
Fire rating and sound reduction:	double skin option can be supplied in a fire-rated version to BS476: Part22:1987 on request* Noise reduction between 28db – 32db



Optional Extras: Door, Access and Protection Systems - page 38



We have created solutions for many including...



Call us today on
+44 (0)1785 242181
and book a site survey...

Could Anchorwall work for you?
Scan the QR code to learn more:



Buildings & Canopies

Temporary. Modular. Quick.



Semi-Permanent

Quick modular installation to create a temporary or semi-permanent building for storage or additional manufacturing space.

Weather protection canopies and air locks can also be created.



Integrated Solution

As partitioning and industrial solutions specialists, Westgate can provide full design, supply and installation of additional products: crash barriers, fast actions doors, internal partitioning and external curtains, as part of your Flexistrukture solution.



Standard or Bespoke

Choose steel or PVC walls and a choice of optional extras to create your fully integrated solution.

Select our standard width up to 35m with unlimited lengths or request a bespoke design to suit your requirements.

Flexistru[®]

temporary external building

Temporary External Structures



Flexistru is a temporary or semi-permanent aluminium framed external building or canopy designed to your exact needs.

Our solutions come with either coated PVC fabric or single layer steel clad sides and insulated panels.

Roofs are also PVC coated fabric and can be air filled for additional insulation. Working with Westgate you benefit from an integrated solution offering optional crash barriers, fast actions doors, internal partitioning and external curtains.



ASK US FOR A FABRIC SAMPLE

Key Features



Standard and Bespoke Sizes



Building can be Sub Divided



Quick, Modular Installation



Door Options and Accessories



Full Project Management



Design and Installation Service

Typical uses include;

- Create additional storage space or manufacturing unit
- Protect employees and/or equipment from the weather
- Create external airlocks and/or loading bays

Benefits

- Quick modular installation
- Option of steel clad (solid steel or sandwich pane) or fabric sides - options to suit your requirements
- Standard and bespoke sizes and designs - bespoke designs to suit your building and existing setup
- Standard widths up to 35m/unlimited lengths (additional widths by joining structures)
- Can be fitted with either quick to deploy curtains or fast action doors and optional extras
- Range of optional extras: crash barriers, fast actions doors, internal partitioning and external curtains
- Dedicated Westgate project delivery team, design and installation services

Technical Data

Frame Construction	The structure frame consists of aluminium profiles (uprights and trusses) and/or of hot-dip galvanized steel parts (foot plates, eave pieces, ridge pieces, purlins, portals etc.). The structure complies with BS EN 13782:2015 for temporary buildings and UK building regulations code BS EN 1991.
Roof and Walls	The roof always consists of extremely high-quality, durable, plastic-coated tarpaulin. The tarpaulin is flame retardant in accordance with DIN 4102 & BS 7837:1996. The wall covering is either made of the same material or - if required - of galvanized and paint-coated trapezoidal sheets or steel sandwich panels.
Snow and Storms	Depending on size, structures possess a snow load of 20 to 100 kg/sqm and can withstand the wind loads required according to DIN EN 13782 up to wind-force 9
Framework	The main framework consists of aluminium profiles made from 6061 alloy and hot dipped galvanised steel connecting parts. This structure complies with the new European norm BS EN 13782:2015 for temporary buildings and UK building regulations code BS EN 1991. Width: Bespoke Length: Bespoke Bay Size: Bespoke Eave Height: Bespoke Snow Load: 20 to 100 kg/sqm Wind Loading: Up to 100km/h, to DIN 13782



Optional Extras: Doors & Barriers - page 38



We have created solutions for many including...



Call us today on
+44 (0)1785 242181
and book a site survey...

Could Flexistore work for you?
Scan the QR code to learn more:



Optional Extras

Integrated Solutions.



Minimise Project Risk

Take the headache out of managing multiple suppliers and programme of works; delivery dates and installation.

With a single supplier your key project milestones are achieved with a single point of contact and responsibility.



Cost Effective

Maximise financial value and ensure that you are receiving the best price for the products required with a single supplier.

We will work hard to help you place budgets in the right areas, without overspending in others.



Time Saving

When multiple products are sourced from multiple suppliers it can take time to ensure these suppliers are all vetted for the appropriate certifications and policies.

Using a single supplier for all those products saves time.

Fastflex®

fast action doors

Integrated Roller and Fold Doors



Fastflex roller and fold fast-action doors can be used internally or externally, supplied standalone or as part of your partitioning project.

Fastflex fast action doors provide customers with managed and optimised traffic flow, temperature control, ingress control and reduced energy consumption.

We offer a range of doors for factory and warehouse environments all of which come with a variety of fabric, size, operation and safety options, allowing our customers to choose a door that best works for them.



ASK US FOR A FABRIC SAMPLE

Key Features



Highest Quality Parts
Guarantee Reliability



Factory Assembly and
Testing Minimises
Installation Times



Can Form Part
of an Integrated
Solution



Range of Fabric
& Size Options



Replacement Parts
Available Quickly



Temperature, Dust
and Ingress Control

Typical uses include;

- Create airlocks for temperature, dust and ingress control
- Internal doors for segregation of different operational areas i.e. production and storage areas
- External doors
- Can be designed and installed as part of a Flexiwall installation

Benefits

- Door assembly includes quality GFA drive train and control gear (unless specified otherwise) to reduce breakdowns and failures
- Doors pre-assembled and tested before leaving the factory for quick and seamless installation
- Anti-crash system self-repairs to reduce operational downtime in the event of impact
- Bespoke sizes available, up to 15m wide
- Range of operation options including radar, photo cell and push button
- Safety light curtain up to 2.5m from floor
- A range of solutions to suit your business needs; choose from Thermal, Acoustic, Antistatic, Hermetic and Food Industry Approved solutions
- Range of fabrics and vision panel options
- Wind loads; doors achieve Wind Class 2 as standard. Solutions available on request to deliver Wind Class 4.
- National certified installation service
- Repair and maintenance service

Technical Data

Max door size internal:	9m(w) x 7m(h) (fold door) 5m(w) x 5(m) (roller door)
Max door size external:	6m(w) x 6m(h) (fold door) 5m(w) x 5(m) (roller door)
Opening speeds:	up to 2.5 m/s (roller door)
Closing speeds:	up to 0.8 m/s (Internal) up to 0.8 m/s (External)
Safety bottom edge protection:	yes
Safety light curtain:	yes (up to 2.5m)
Self-repairing zip edge:	roller door only
Materials:	Frame: Galvanized (EN 10346:2009) or powder coated steel guide rails, curtain hood and motor cover (316 grade stainless steel option)
Electricity supply:	Single phase or 3 phase (depending on door size)



We have created solutions for many including...



Call us today on
+44 (0)1785 242181
and book a site survey...

Could Fastflex work for you?
Scan the QR code to learn more:



Flexistrip®

pvc doors & curtains

Fixed or Retractable PVC Strips

Flexistrip PVC strip doors and curtains are available in a range of material finishes and specifications.

It can be used as a static option or mounted on a track to push aside when needed for larger loads. Westgate Global offer a self-installation kit or national supply and installation service.

Benefits

- Self-extinguishing
- Comprehensive range of strip and track options, including sliding
- Quick turnaround from UK stock
- Operating temperatures from -38°C to +40°C

Typical uses include;

- Fixed or retractable access for temperature-controlled areas
- Welding screens
- Segregate processes and equipment to prevent spread of sparks
- Create a physical barrier to reduce fumes, odours, dust and noise
- Employee weather protection for external openings
- Used in conjunction with Westgate partitioning systems to provide an integrated solution

Technical Data

Material composite:	flexible self-extinguishing PVC in a range of colours (food grade materials)
Strip width:	between 200mm – 400mm
Strip thickness:	between 2mm – 4mm
Overlap options:	between 50% to 100%
Headrail options:	universal keyrail, sliding track, hook on track

Easiguard®

steel protection system

Barrier Protection

Easiguard is a steel barrier protection system designed to protect walls, doors, machinery, racking and personnel from potential collisions.

Easiguard can be supplied with or without installation and a range of barrier options and configurations are available.

Benefits

- Available as supply only or supply and installation
- Comprehensive range of barrier options available to meet specific project requirements
- Powder coated or hot dipped galvanised finish
- Supplied ready for surface mounting or concreting in to the ground
- Comprehensive range of barriers and finishes
- Supply only or supply and installation
- Use in conjunction with Westgate partitioning systems to provide an integrated solution

Typical uses include;

- Protect walls, doors and machinery from potential collision and fork lift damage
- Create safe pedestrian walkways to protect personnel
- Create designated work areas and site offices within factories and warehouses

Technical Data

Our Easiguard range is bespoke dependant on your business and project requirements, please contact Westgate to speak to a sector specialist about your options

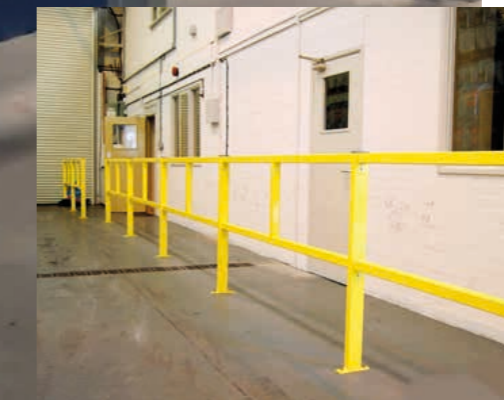

Solar Control

Prevent Wastage.



Cost Effective

Roof light covers can help to reduce wastage and/or energy costs so offer a quick pay back period when it comes to your upfront investment.

Alternative to painting roof lights with no lasting damage or ongoing maintenance.



No Damage

Designed to work with your buildings current roof light configuration, solar control panels are installed without damage. Covers can be removed at the end of occupancy without lasting damage to the building and therefore no additional costs.



No Compromise

Painting or covering panels reduces natural light, Easipanel roof light covers maintain up to 50% natural light, whilst reducing heat by up to 53%.

The system is backed by a manufacturer and installation guarantee up to 10 years.

Easipanel

reflective roof light cover

Double Coated Polycarbonate Roof Light Cover



Easipanel is designed to reduce heat and/or glare and UV from entering via roof lights, with a need to maintain natural light.

Multiwall polycarbonate sheets are custom designed and installed to suit your buildings bespoke roof light configuration and maintain more natural light than painting panels. The 25mm double coated polycarbonate panel offers maximum heat and glare reduction while retaining up to 50% natural light.

Installation methods and components used ensure no lasting damage to the existing roof or roof lights.

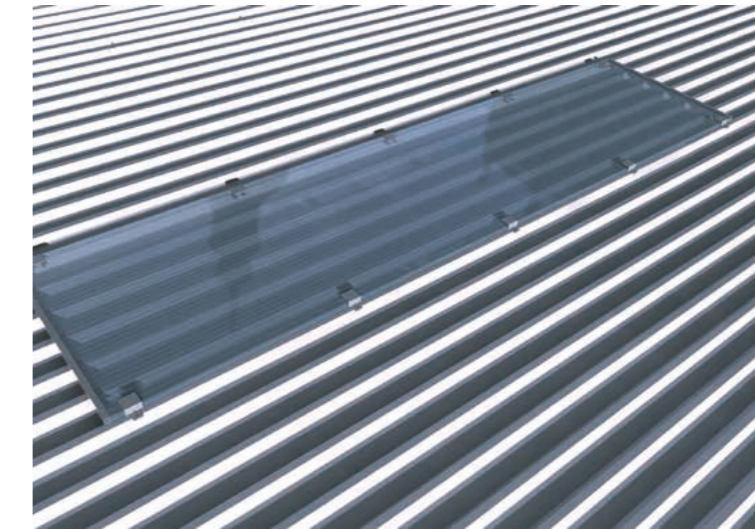

Key Features



Maintain up to 50% Natural Light



No Lasting Damage to Building



Bespoke Bracket for Secure Grip



10 Year Panel Guarantee



Heat Reduction up to 50%



Reduction in Wastage

Typical uses include;

- Prevent roof light heat and glare spoiling products on high bay racking
- Reduce glare and diffuse light from roof lights to maintain safe levels of health and safety
- Maintain and manage consistent temperatures
- Reduce product fading from UV rays

Benefits

- Fire retardant to BS 476 part 7 & EN 13501 – B s1 d0
- Bespoke fabricated brackets ensure panels are secured in place
- Installations use existing roof screw holes to prevent additional damage to the building
- All screws and washers replaced to ensure a tight grip and seal. Washers are bonded galvanised steel to reduce moisture ingress
- Butyl tape used under each bracket to prevent corrosion between new and old metals and maximise the integrity of the roof structure
- Panels are designed to allow airflow and prevent condensation build up
- Polycarbonate panels guaranteed for 10 years against loss of light due to UV degradation (manufacturers warranty)
- Roof mounting system, (method of fixing complete panel to roof) guaranteed for 3 years
- Panels can be removed without lasting damage at the end of an occupancy period

Technical Data

Standard panel size:	1m (w) x 2m (l)
Material composite:	25mm double coated polycarbonate
Fixing methods:	bespoke fabricated brackets secured with bonded galvanised screws and washers (as standard one bracket per linear metre*) <small>*Fixings use existing holes to prevent additional building damage so brackets can be less or more than the stated standard, this is confirmed at site survey and quotation stage.</small>
Light retention:	up to 50% (dependent upon environment)
Heat reduction:	approx. 50% (depending on specific environments)
U-Value (insulation):	1.4 W/m ² K
Guarantee:	10 year panel guarantee

Installation

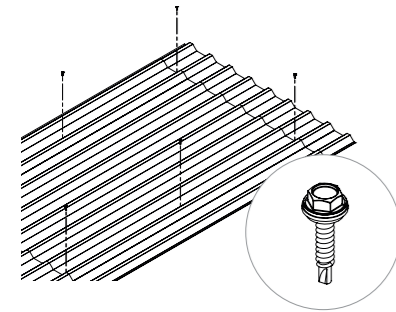

Old screws and washers removed.

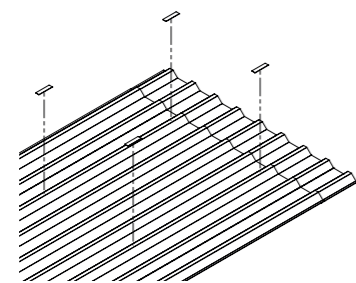

Sealing tape is placed on the roof to help position the panel in place.

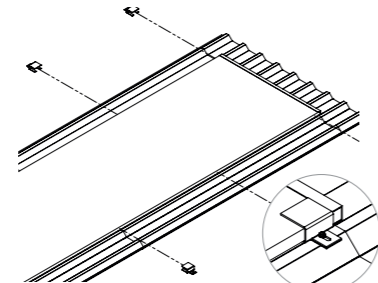

Bespoke fabricated brackets are lined up with existing screw holes.

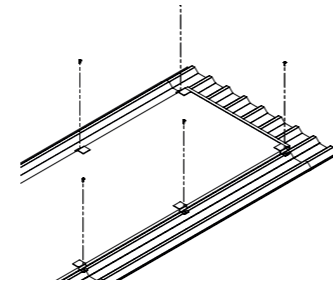

New screws and bonded galvanised washers secure each bracket and panel in place.



Call us today on
+44 (0)1785 242181
and book a site survey...

Could Easipanel work for you?
Scan the QR code to learn more:



Contact Us

Call us today on +44 (0)1785 242181
or email us at salesteam@westgate-global.com
and book a site survey with one of our experts...



Get in touch today

westgate-global.com

+44 (0)1785 242181

salesteam@westgate-global.com

Westgate House, Verulam Road, Stafford ST16 3EA

© Westgate Global Ltd / 4.0-200224