

Flexiscreen®

high grade building screen



Flexiscreen is a **temporary floor-to-ceiling building and dust screen** used to contain dust during construction, flooring, installation and extension works within live manufacturing, production and warehouse environments.

Used for both **internal and external applications**, this versatile screening system ensures a tight seal around ducts, pipes, steel work and at ceiling level offering a **robust alternative to traditional scaffold sheeting methods**.

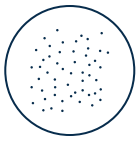

Over 99% Dust Containment

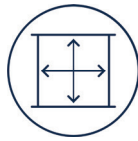

Floor to ceiling; Any Height and Length



No Mess, Quick/ Easy Installation



Antibacterial Materials



Fire Rated Materials on request

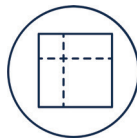

Takes up Minimal Floor Space

Features and Benefits

Quick and clean installation process	<ul style="list-style-type: none"> • Maintain existing production schedules • Dust free installation
Suspended panel based system	<ul style="list-style-type: none"> • Requires minimal floor space • No need for scaffold structure
Easily fits around existing penetrations	<ul style="list-style-type: none"> • Creates over 99% dust tight seal easily
Manufactured in the UK	<ul style="list-style-type: none"> • Quick turnaround
Installs to any height and length (subject to survey)	<ul style="list-style-type: none"> • Works in all environments - ideal for tall buildings • Internal or external applications
Antibacterial materials available	<ul style="list-style-type: none"> • Works in sensitive areas including those adhering to BRC accreditations
Structural and windload calculations available	<ul style="list-style-type: none"> • Peace of mind for your project

Installation

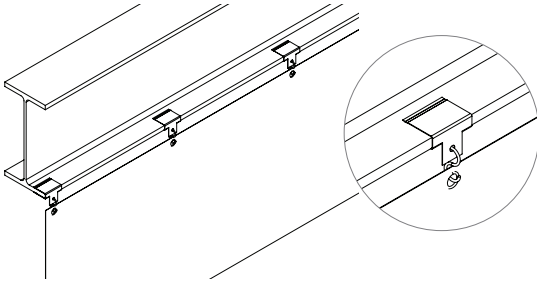

As standard, panels are suspended using existing steelwork, clips and s-hooks. (Bespoke hanging method available).

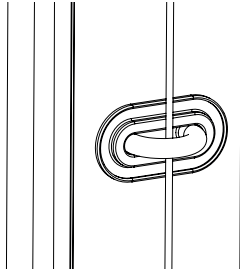
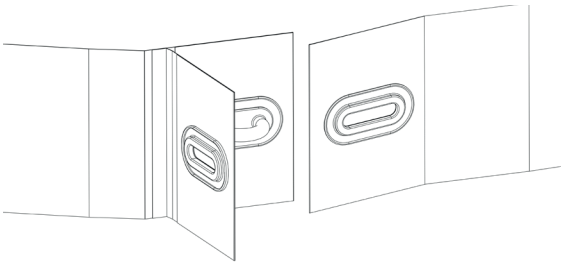

Panels are joined together using our unique v-overlap system.

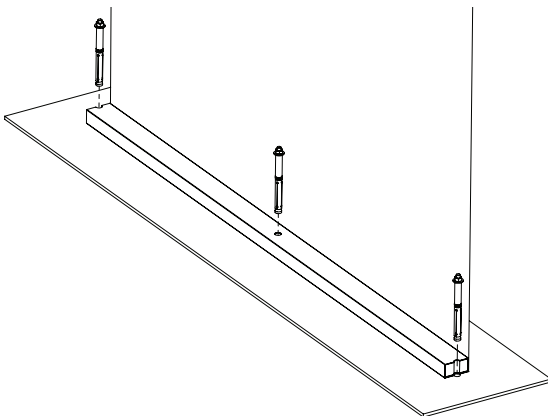

As standard, panels are tensioned and secured using battens fixed to the floor. (Bespoke fixing methods available).

This fact sheet is for illustrative purposes only and based on the latest information at the time of print. Installation methods may vary depending on specific project requirements. Westgate Global reserve the right to make changes at any time without notice.

J229-WFD-PFS-FS-270224 © Westgate Global Ltd

Technical Specifications

Material Composite	Main product is polyester reinforced fire-retardant fabric with PVC coatings. We also supply a non-combustible woven glass fabric with PU coating <small>(*range of base fabric and coatings depending on your requirements)</small>
Material Weight	between 175gsm-840gsm
Tensile Strength	between 800N-3400N / 50mm
Tear Strength	between 250N-850N
Material Fire Rating	BS 5867:2008 Part 2 Type A & B, Warrington Certifire TS62 & TS63, EN13501-1 A2s1d0, EN13501-1 Bs2d0, EN13501-1 Cs2d0 <small>(*subject to material specification, all fire ratings supplied at quote stage)</small>
Operating Temperature	between -40 / +70 degree centigrade <small>(*dependent on fabric type)</small>

Flexiscreen is quick and clean to install and during phased works can be moved and reconfigured, offering a robust and cost-effective alternative to scaffold sheeting. Available for both internal and external applications.

